

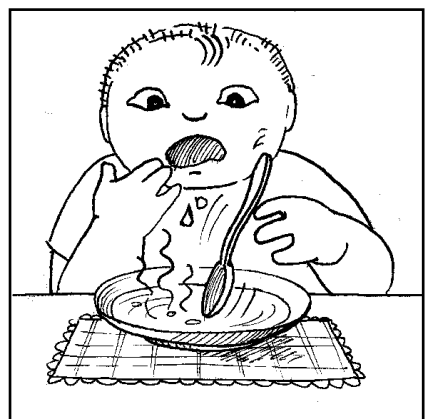

# Pozor, pálí!

Spoj obrázky, které patří k sobě.

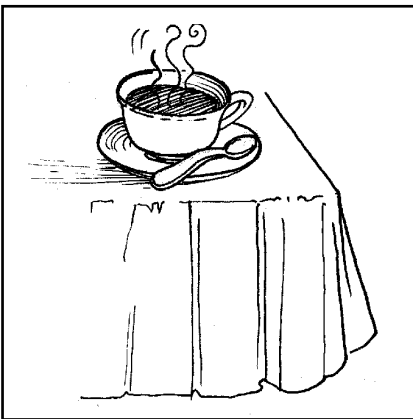

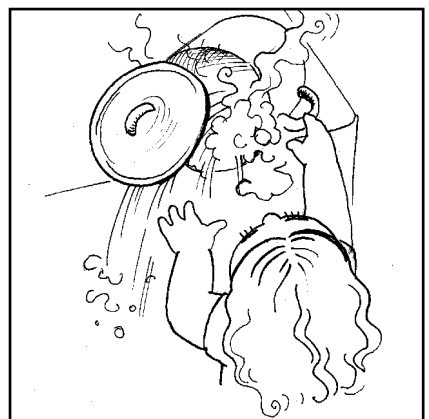
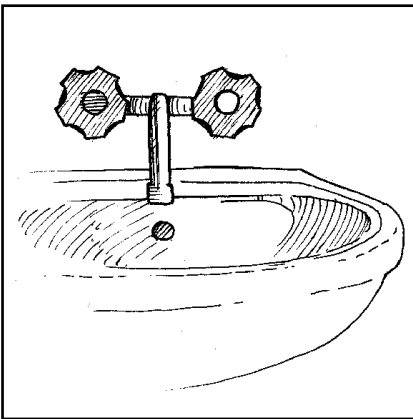
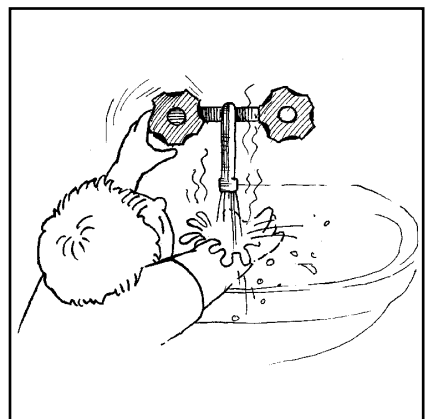
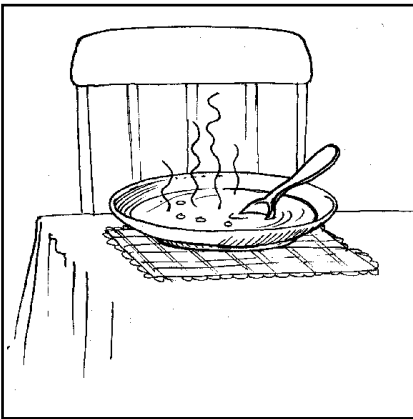
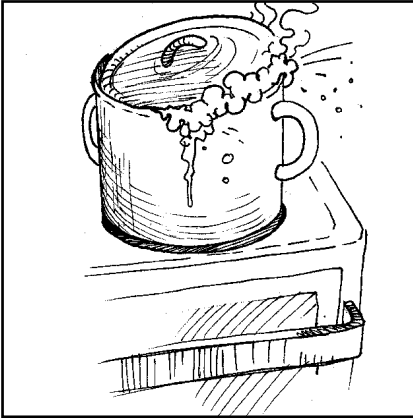

# Jak zkrotit silnici

Pokud děti na obrázku jednají správně, vybarvi kolečko u jejich nohou zeleně. Pokud jednají špatně, vybarvi kolečko červeně.

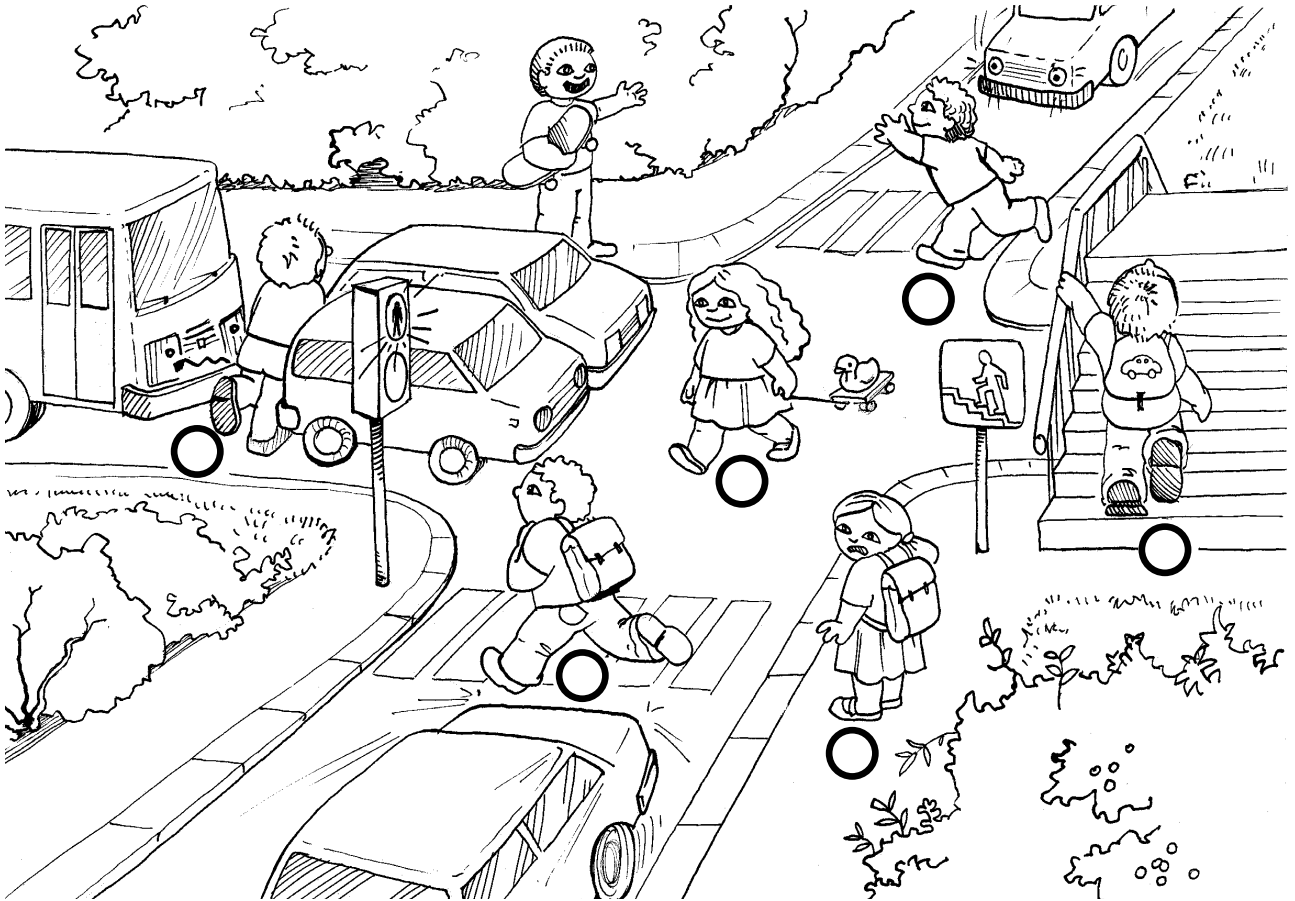

Zakroužkuj, co potkávaš při cestě do školy.

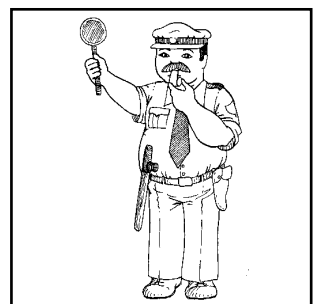
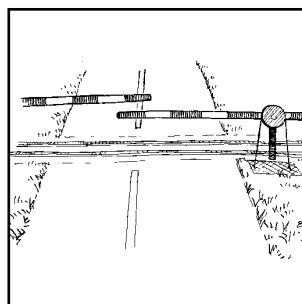
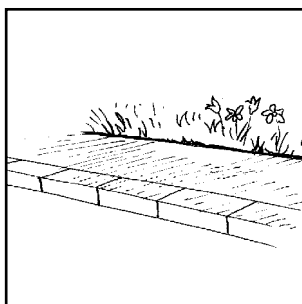
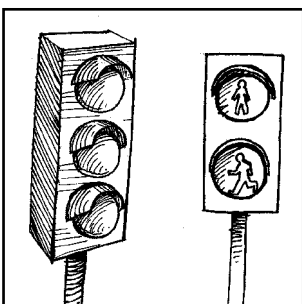
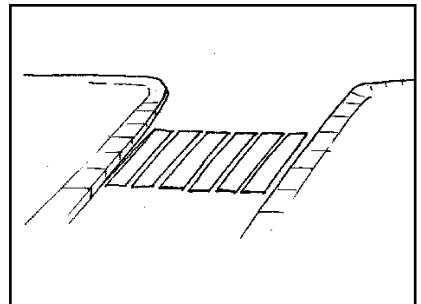
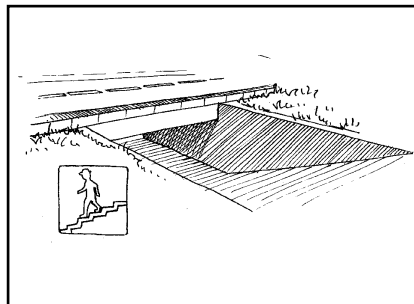
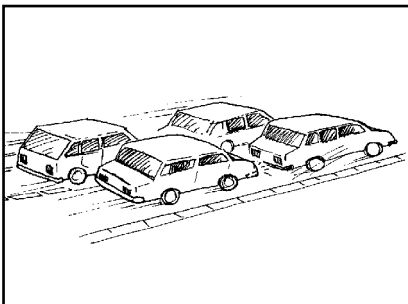



# Co tě může zachránit?

Spoj, co k sobě patří.

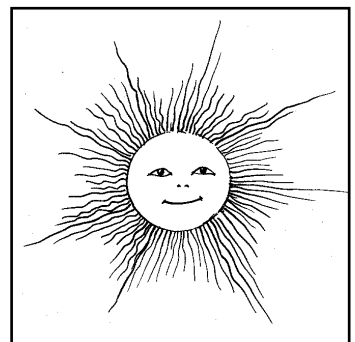
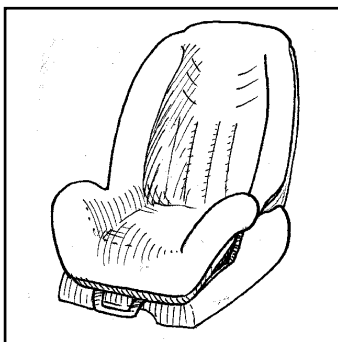
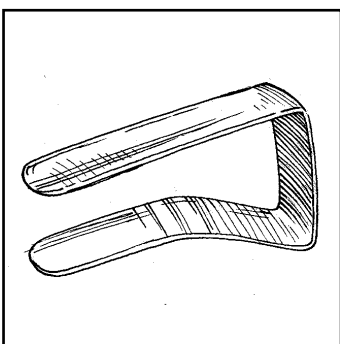
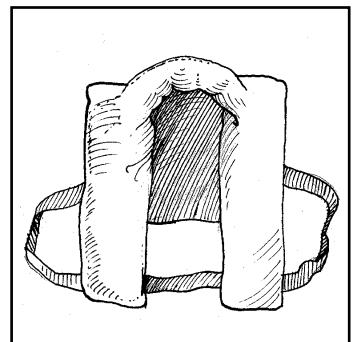
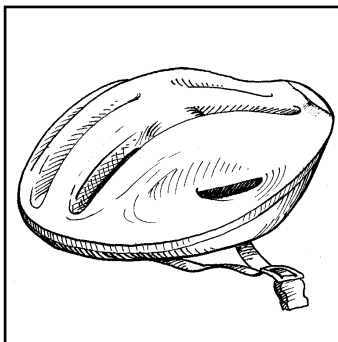
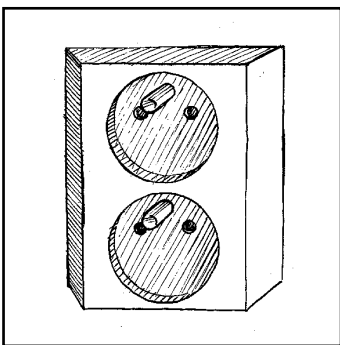
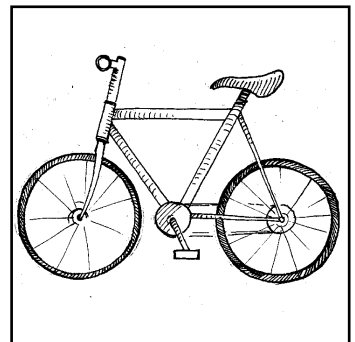
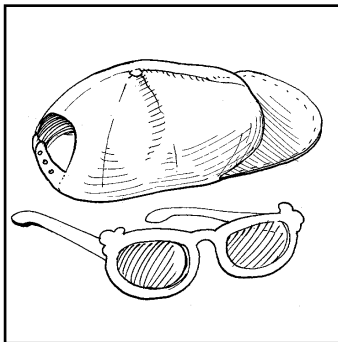
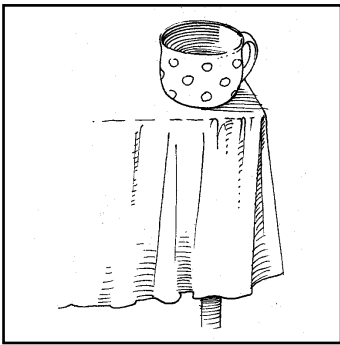
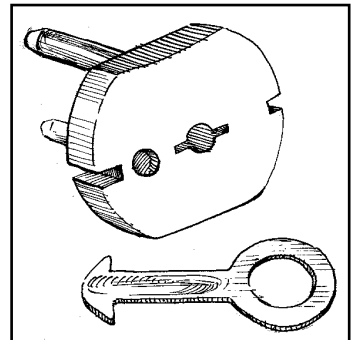
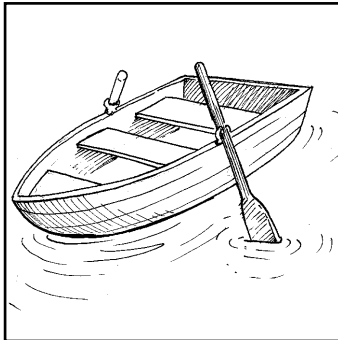
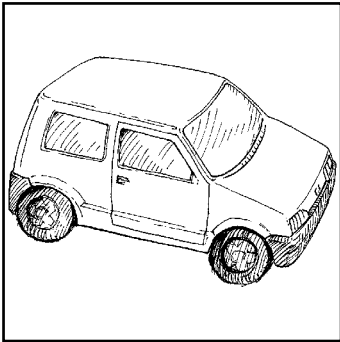



# S čím si smím a nesmím hrát

Spoj nebezpečný předmět s tím, co hrozí.

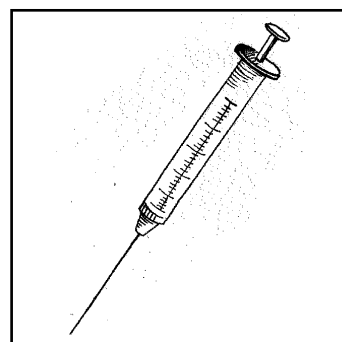
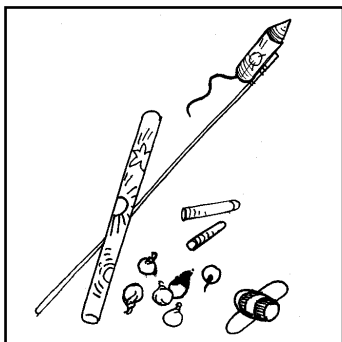
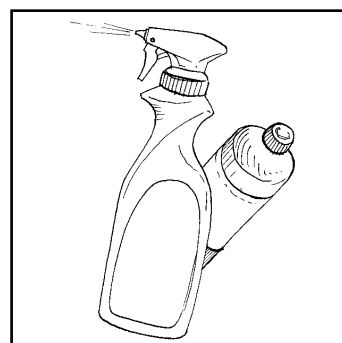
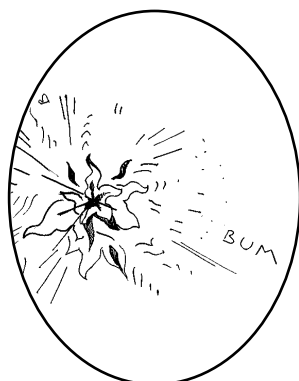
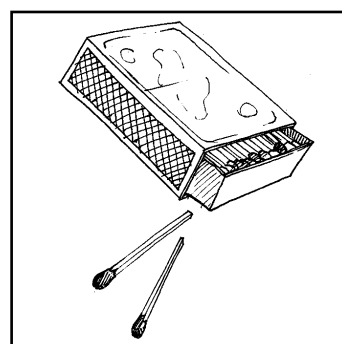
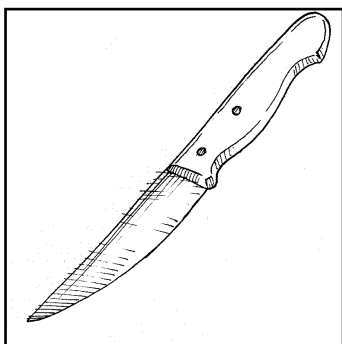
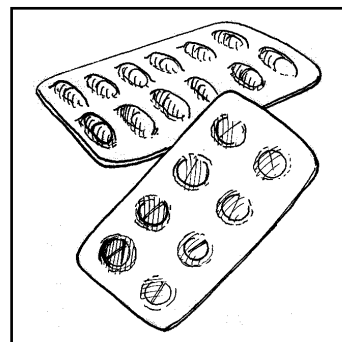
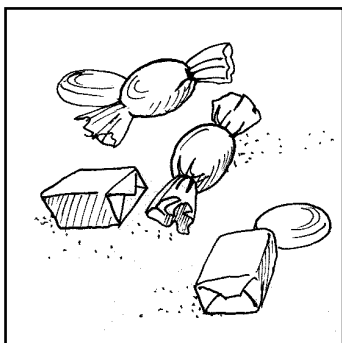



# Když mám psa

Kam může který pes na procházku?

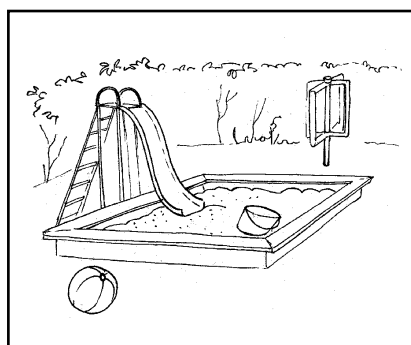
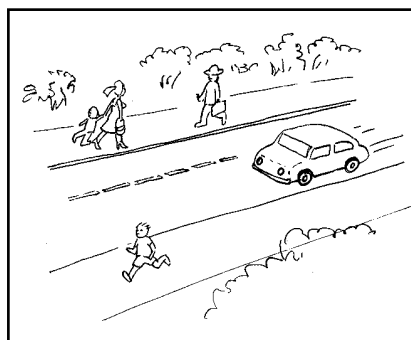
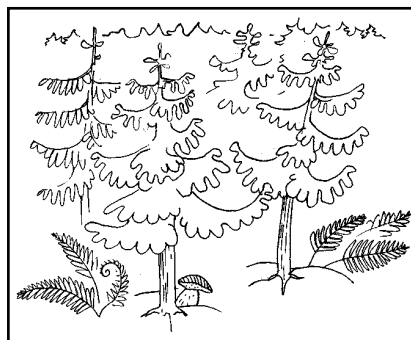
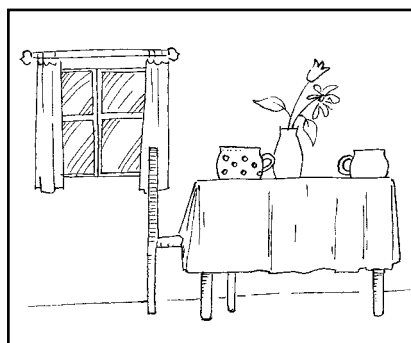
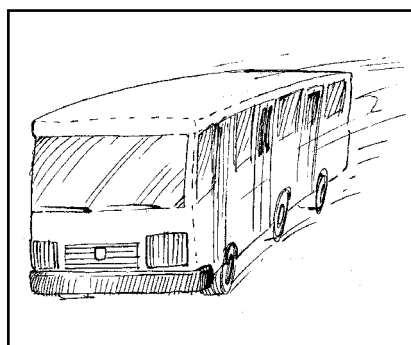
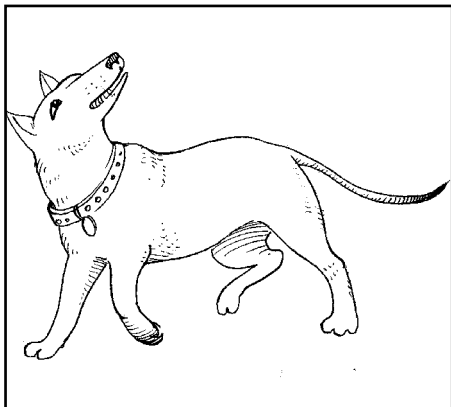
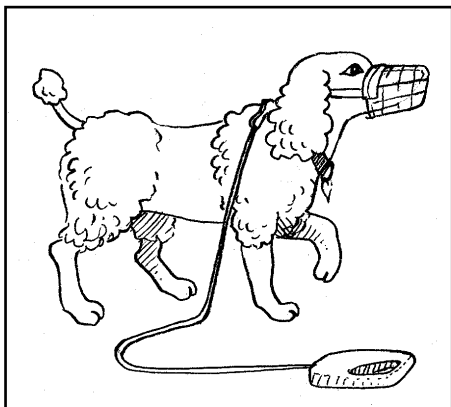
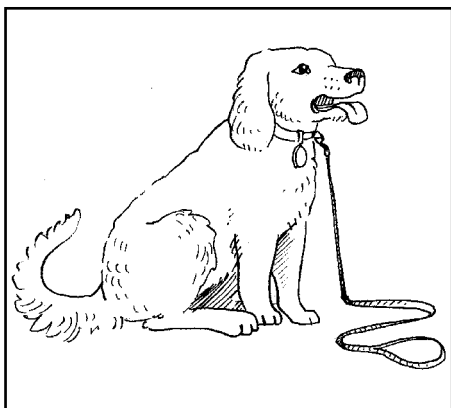
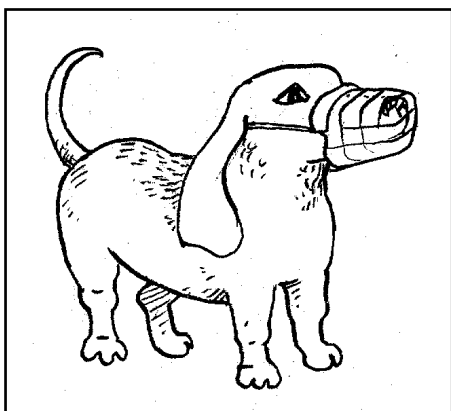



# Co udělám?

Zakroužkuj obrázky, kde se děti zachovaly správně, a přeškrtni ty, kde udělaly velikou chybu. Co by se jim mohlo přihodit?

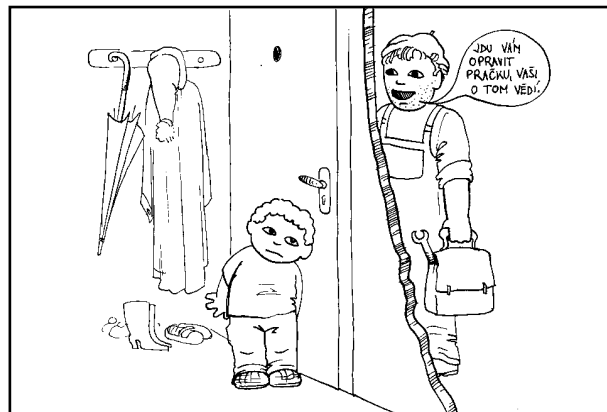

Už se ti někdy stalo něco podobného? Co jsi udělal?



# Co udělám?

7

Zakroužkuj obrázky, kde se děti zachovaly správně, a přeškrtni ty, kde udělaly velikou chybu. Co by se jim mohlo přihodit?



Už se ti někdy stalo něco podobného? Co jsi udělal?



# Co říkají značky?

8

Spoj dopravní značky s jejich názvy a vybarvi je.

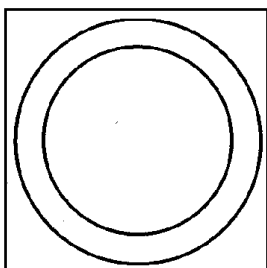

ZÁKAZ VJEZDU VŠECH  
VOZIDEL  
(V OBOU SMĚRECH)

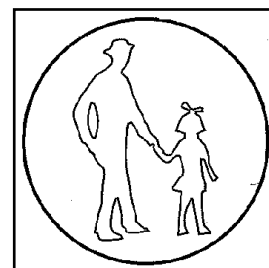

STEZKA PRO CHODCE

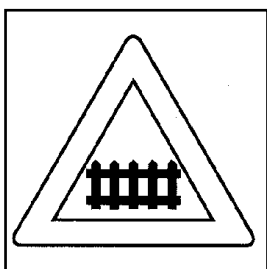

HLAVNÍ SILNICE

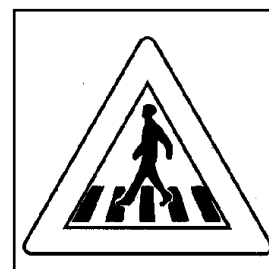

KŘÍŽOVATKA S VELDEJŠÍ  
SILNICÍ

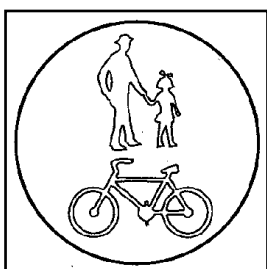

POZOR, PŘECHOD PRO  
CHODCE

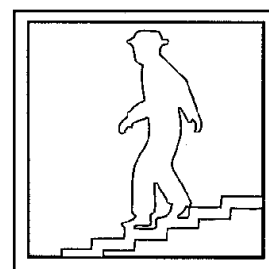

KŘÍŽOVATKA

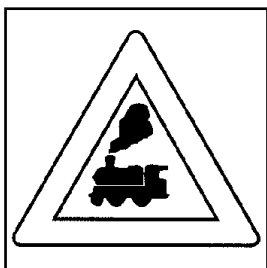

ZÁKAZ VJEZDU VŠECH  
VOZIDEL

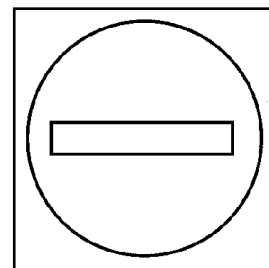

PODCHOD

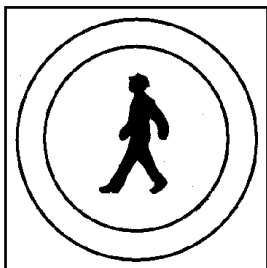

ZÁKAZ VSTUPU CHODCŮ

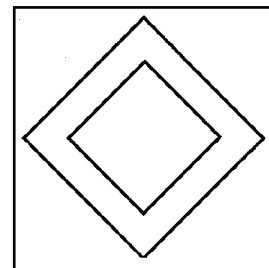

ŽELEZNIČNÍ PŘEJEZD  
BEZ ZÁVOR

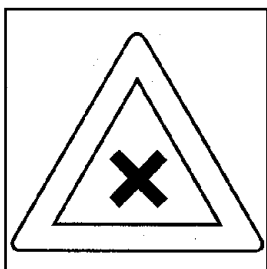

ŽELEZNIČNÍ PŘEJEZD SE  
ZÁVORAMI

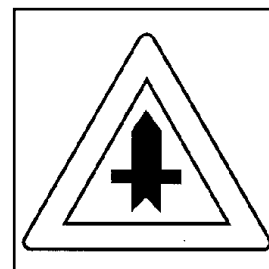

STEZKA PRO CHODCE  
A CYKLISTY





Víš, co musí udělat cyklista předtím, než odbočí na křižovatce? .....

.....  
.....

Jakmile s kolem vyjedeš na silnici, musíš jako ostatní řidiči znát a dodržovat .....

..... a pozorně sledovat .....

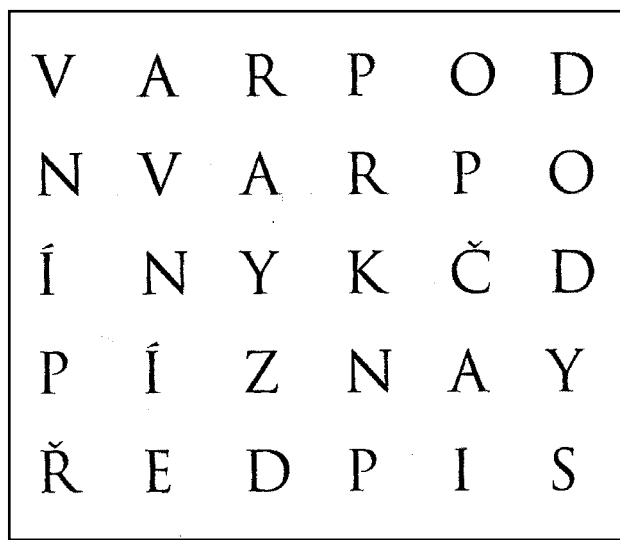
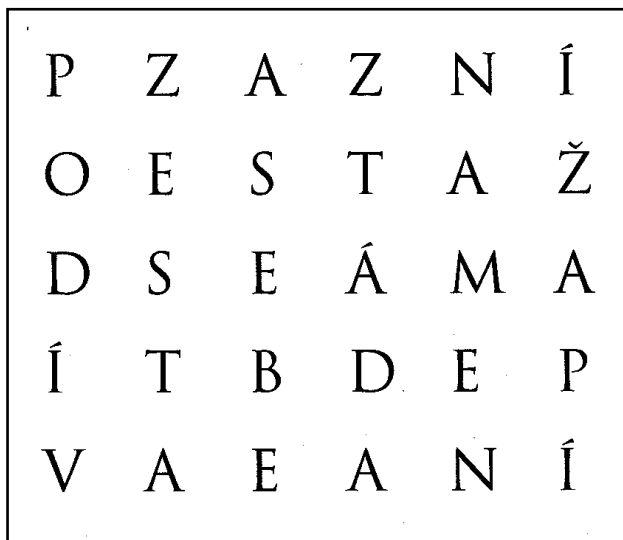

Víš, od kolika let smíš jako cyklista jezdit sám po silnici? Nezapomeň, že musíš znát dobře dopravní předpisy a ovládat bezpečně jízdu na kole?

